



> SG-BWS-T4
Safety Control Unit



ORIGINAL INSTRUCTIONS (ref. 2006/42/EC)

Datalogic S.r.l.
Via S. Vitalino 13
40012 Calderara di Reno
Italy

SG BWS-T4 Instruction Manual

Ed.: 01/2018 Rev. B

© 2012 – 2018 Datalogic S.p.A. and/or its affiliates ♦ ALL RIGHTS RESERVED. ♦ Without limiting the rights under copyright, no part of this documentation may be reproduced, stored in or introduced into a retrieval system, or transmitted in any form or by any means, or for any purpose, without the express written permission of Datalogic S.p.A. and/or its affiliates.

Datalogic and the Datalogic logo are registered trademarks of Datalogic S.p.A. in many countries, including the U.S.A. and the E.U. All other trademarks and brands are property of their respective owners.

Datalogic shall not be liable for technical or editorial errors or omissions contained herein, nor for incidental or consequential damages resulting from the use of this material.

29/01/18

CE COMPLIANCE

CE marking states the compliance of the product with essential requirements listed in the applicable European directive. Since the directives and applicable standards are subject to continuous updates, and since Datalogic promptly adopts these updates, therefore the EU declaration of conformity is a living document. The EU declaration of conformity is available for competent authorities and customers through Datalogic commercial reference contacts. Since April 20th, 2016 the main European directives applicable to Datalogic products require inclusion of an adequate analysis and assessment of the risk(s). This evaluation was carried out in relation to the applicable points of the standards listed in the Declaration of Conformity. Datalogic products are mainly designed for integration purposes into more complex systems. For this reason it is under the responsibility of the system integrator to do a new risk assessment regarding the final installation.

Warning

This is a Class A product. In a domestic environment this product may cause radio interference in which case the user may be required to take adequate measures.

INDEX

1. GENERAL INFORMATION	2
1.1. Purpose of this document:	2
1.2. Intended readers:	2
1.3. Usage information:	2
2. PRODUCT GENERAL DESCRIPTION	3
2.1. Package Content	3
2.2. Products components and interface	3
2.3. Safety sensors	4
2.4. Main functions managed by the control unit:	5
2.5. Typical Applications	5
3. INSTALLATION	7
3.1. Safety information	7
3.2. Precautions to be observed for the choice and installation of the device	7
3.3. General information on sensors positioning	7
3.4. Minimum installation distance	8
3.5. Minimum distance from reflecting surfaces	10
3.6. Sensors Interference	11
3.7. Installing the safety control unit	12
3.8. Installing the sensors	12
4. ELECTRICAL CONNECTION	14
4.1. Important installation tips	14
4.2. External relays connection for machine control	14
4.3. Minimum connections (1 photocell, no EDM, automatic restart)	15
4.4. Complete list of connections	16
4.5. Connecting the safety photocells:	17
4.6. Connecting the safety photocells for SG-BWS-T4-2 model:	18
4.7. Connecting the external relays and EDM	19
4.8. Reset mode and connection of the Start/Test/Reset push-button	20
5. COMMISSIONING	22
5.1. Screen indications upon switch-on	22
5.2. Safety devices alignment	22
6. DIAGNOSTICS AND WARNINGS	23
6.1. Normal operation signalling	23
6.2. Failure state signalling	24
7. PERIODICAL CHECKS AND WARRANTY	25
7.1. Periodical checks	25
7.2. Warranty	25
8. DEVICE MAINTENANCE	26
8.1. Product disposal	26
9. TECHNICAL DATA	27
10. ORDER DATA	29
11. OVERALL DIMENSIONS	30
11.1. SG-BWS-T4	30
11.2. S5-ST2, S5-ST4, SL5-ST4, S300	30
12. APPENDIX	31
12.1. FIGURE INDEX:	31
12.2. TABLES INDEX:	31

1. GENERAL INFORMATION

Read this section carefully before implementing the instructions given in this manual and starting up the SG-BWS-T4 safety system.

1.1. Purpose of this document:

These instructions for use are addressed to the manufacturer technicians or staff operating the machine and give all necessary instructions for correct and safe assembly, setup, electric connection and commissioning of the SG-BWS-T4 safety system.

Scope of this document excludes information about use of the machine the safety system is installed to.

1.2. Intended readers:

The instructions for use given herein are addressed to designers, manufacturers and persons in charge of the safety of systems to be equipped with the SG-BWS-T4. They are also addressed to the staff in charge of installing the SG-BWS-T4 to a machine, commissioning it or servicing it.

1.3. Usage information:

These instructions for use contain the following details about the SG-BWS-T4:

- installation	- diagnostics and troubleshooting
- electrical connection	- user interface warnings
- commissioning and setup	- conformity and type approval
- application	- care and maintenance

Tab. 1 User manual main contents

Designing and using safety devices to integrate to the SG-BWS-T4 requires specific know-how which is not included in this document. In particular, the applicable industry standards shall be met.

Acronyms used:

ESPE	Electro sensitive protective equipment: used instead of SG-BWS-T4
EDM	External device monitoring
OSSD	Output signal switching device: output signal that can control an external safety circuit.
LED	Light emitting diode

Definitions, symbols used:

	Constant viewing of characters, e.g. A
	Alternated viewing of characters, e.g. U and 5

SAFE	The red LED is always ON
NORMAL	The LED is OFF
NORMAL	The green LED flashes



Warning: indicates safety-related critical information. Carefully read and follow given instructions.

2. PRODUCT GENERAL DESCRIPTION

2.1. Package Content

- Safety Control Unit SG-BWS-T4
- Quick operations guide
- Six-monthly checklist for periodic check and maintenance

2.2. Products components and interface

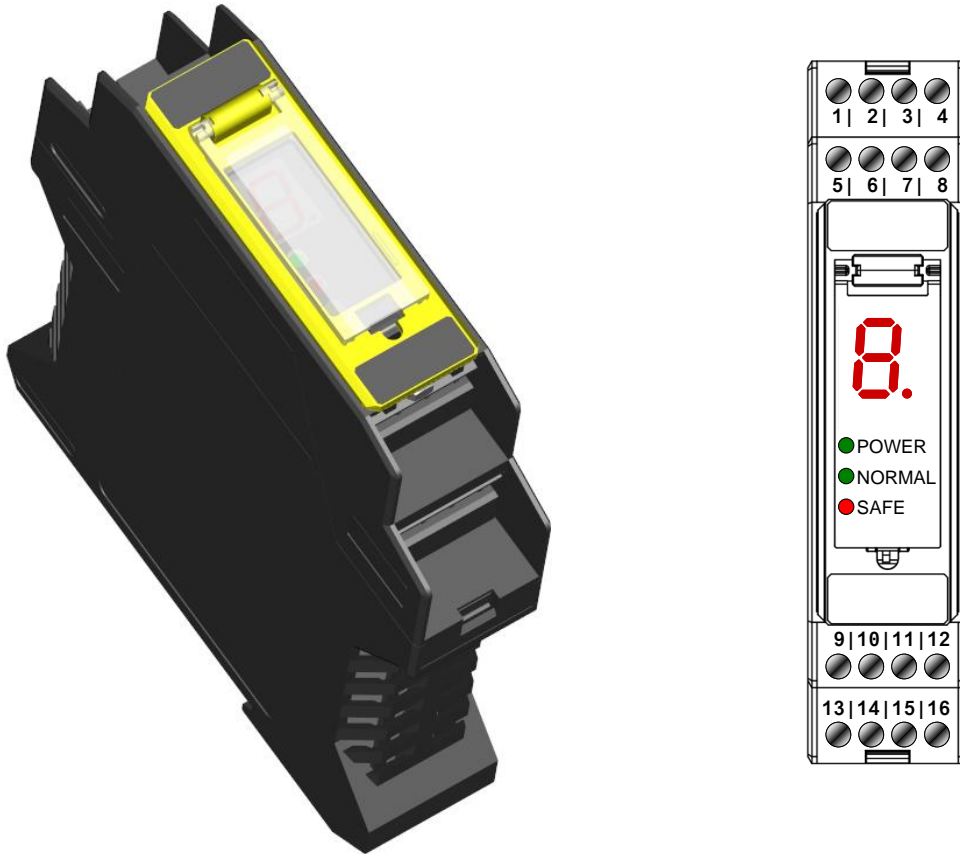

Fig. 1 SG-BWS-T4-MT Appearance and user interface

SG-BWS-T4 safety system consists of a control unit enclosed in a plastic housing to be installed on OMEGA/DIN rail equipped with 16 screw clamps that can be connected up to 4 sets of photocells of the S5-ST, SL5-ST, S300 series.

System was designed making reference to the following regulations and standards:

EN 61496-1: 2004	Safety of machinery: electrosensitive protective equipment. Part 1: General requirements and tests.
CLC/TS 61496-2: 2006	Safety of machinery: electro-sensitive protective equipment. Particular requirements for equipment using active optoelectronic protective devices.

The control unit fits two safety outputs (OSSD) controlled according to the status of each and every sensor connected to the system: when a photocell detects any dangerous condition, this disables the outputs and stops the machine, duly connected to OSSD.

At the top of SG-BWS-T4 is user interface for viewing warnings.

Further to the 7-segment display (for diagnostics purposes) the warning components include 3 LEDs:

LED	Indication
● POWER	Device is powered correctly
● NORMAL	Safety outputs closed
● SAFE	Safety outputs open

Tab. 2 Signalling LEDs

2.3. Safety sensors

4 types of photocells can be connected to the safety control unit:

- **S5-5-X-X-SG-ST2: Type 2 safety photocell emitting infrared beams.**
- **S5-5-X-X-SG-ST4: Type 4 safety photocell emitting infrared beams.**
- **SL5-5-X-X-SG-ST4: Type 4 safety photocell emitting long-distance red laser beam.**
- **S300-5-X-X-ST4: Type 4 safety photocell for long-distance applications.**

See section 10 “Order data” for further details about available photocell models.



Using the above photocells independently from SG-BWS-T4 does not meet EN 61496-1 and CLC/TS 61496-2 requirements and is thus not allowed.

Connection of Type 2 photocells results in the whole system category downgrade to Type 2.

S5 and SL5 sensors are housed in plastic tube casings featuring M18x1 thread.

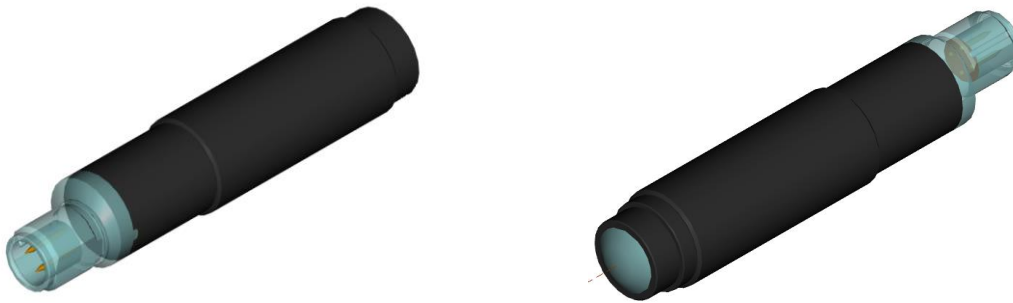

Fig. 2 Safety single beam photocells S5,SL5 series (appearance)

The photocells are equipped with LEDs for operation status indication:

Sensor	LED	Indication
S5/SL5/S300 Emitter	● Green	Sensor correctly powered
S5 Receiver	● Green	Sensor correctly powered
	○/★ Green	Poor/insufficient signal received
	● Red	Output active
	○ Red	Output not active
SL5/S300 Receiver	● Green	Sensor correctly powered
	○/★ Green	Poor/insufficient signal received
	● Yellow	Output active
	○ Yellow	Output not active

Tab. 3 Photocells signalling

Please refer to the relevant user manual for further details about photocells operation.

2.4. Main functions managed by the control unit:

- **Manual/Automatic restarting: select whether the safety outputs are automatically closed when danger condition no longer applies or if this should happen after a manual enabling command output through a restarting selector.**
- **EDM: the control unit can monitor any external contactors possibly connected downstream.**

2.5. Typical Applications

The SG-BWS-T4 system is typically used as a protection to the access to dangerous areas on machines or systems. The sensors are fixed and installed to the access area at the suitable safety distance from the nearest danger source and output a stop control to the machine or system, if the light beam is interrupted.

Hereafter are shown some application examples with SG-BWS-T4.

Example 1: Automatic warehouses

The access of both moving bay sides has to be protected in order to prevent operators entering the dangerous area.

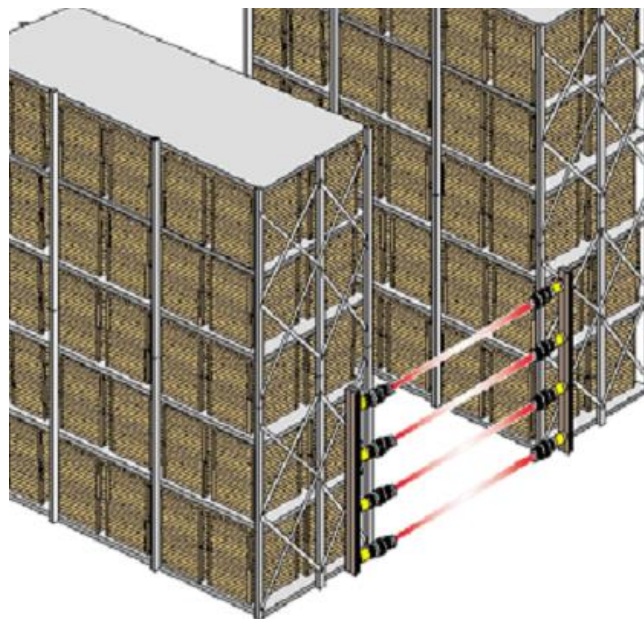

Fig. 3 Automatic warehouses protection with photocells

Solution: safety photocells are installed on both sides of the bay that are connected and driven by one SG-BWS-T4 control unit.

Advantages: the use of tubular photocells enables installation even in reduced spaces in the warehouse structure. SG-BWS-T4 is ideal for all applications where protection has to be guaranteed without additional safety functions.

Example 2: SMD machine protection

The access to a dangerous area must be enabled in order to carry-out maintenance procedures. The access must be allowed by stopping only the specific area by opening the doors and not the entire machine.



Fig. 4 Doors control by means of safety photocells

Solution: SG-BWS-T4 is able to detect the door opening by using one or more photocells by intersecting the interrupted beams, guaranteeing the safety condition.

Advantages: all the safety interlocks can be replaced on each door thanks to the use of photocells and so reducing the plant cost as well as increasing flexibility.

3. INSTALLATION

3.1. Safety information



For a correct and safe use of the SG-BWS-T4, the points considered in this section must be observed.

The stopping system of the machine must be electrically controlled. This control system must be able to stop the dangerous movement of the machine within the total machine stopping time T as per par. 3.4, and during all working cycle phases.

The safety system should be installed and connected by a qualified technician in compliance with the instructions specified in this manual and industry rules.

The photocells must be securely installed in a particular position so that access to the dangerous zone is not possible without the interruption of the beams (see 3.3 "General information on sensors positioning").

The personnel operating in the dangerous area must be well trained and must have adequate knowledge of all the operating procedures of the safety control unit.

The START and TEST buttons must be located outside the protected area because the operator must check the protected area during all Test and Reset operations.

Please carefully read the instructions for the correct functioning before powering the SG-BWS-T4.

3.2. Precautions to be observed for the choice and installation of the device



Make sure that the protection level assured by the device is compatible with the real danger level of the machine to be controlled, according to EN 954-1 and EN 13849-1.

- **The OSSD outputs of the ESPE must be used as machine stopping devices and not as command devices. The machine must have its own START command.**
- **The dimension of the smallest object to be detected must be larger than the resolution level of the installed safety sensors.**
- **The ESPE must be installed in a room complying with the technical characteristics indicated in section 9 "Technical data".**
- **Do not install the sensors close to strong and/or flashing light sources or close to similar devices.**
- **Strong electromagnetic disturbance might negatively affect device operation. Should this be the case contact Datalogic Technical Service.**
- **The operating distance of the safety sensors can be reduced in presence of smog, fog or airborne dust.**
- **A sudden change in environment temperature, with very low minimum peaks, can generate a small condensation layer on the sensors lenses and so jeopardise functioning.**

3.3. General information on sensors positioning

Pay special care when positioning the safety photocells so to offer effective protection. The safety sensors should be installed in such a way that the dangerous area can only be entered after detecting the sensitive area.

Photocells position is fixed by normative and must respect measures in Tab. 4.



Under standard operating conditions, machine starting must not be possible while operators are inside the dangerous area.

If the operator is able to enter the dangerous area although ESPE positioning, an additional mechanical protection must be mounted to prevent the access.

3.4. Minimum installation distance

The safety device must be positioned at a specific safety distance. This distance must ensure that the dangerous area cannot be reached before the dangerous motion of the machine has been stopped by the ESPE.

The safety distance depends on 4 factors, according to the EN 13855 Safety Norm:

- **Response time of the ESPE (the time between the effective sensors beam interruption and the opening of the SAFCN contacts).**
- **Machine stopping time (the time between the effective opening of the contacts of the ESPE and the real stop of the dangerous motion of the machine).**
- **ESPE resolution.**
- **Approaching speed of the object to be detected.**

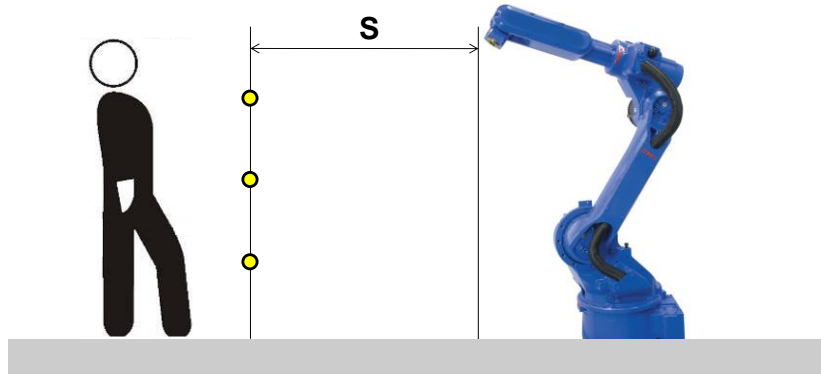

Fig. 5 Safety Distance

The following formula is used for the calculation of the safety distance:

$$S = K (t_1 + t_2 + t_3) + C$$

where:

- S = Minimum safety distance in mm
- K⁽¹⁾ = Speed of the object, limb or body approaching the dangerous area in mm/s
- t₁ = SG-BWS-T4 response time in seconds (0.029)
- t₂ = The higher response time of all times for the safety sensors connected to SG-BWS-T4
- t₃ = Machine stopping time in seconds
- d = Resolution of the system.
- C⁽²⁾ = Additional distance based on the possibility to insert the body or one of body parts inside the dangerous area before the protective device trips.

(1) K is:

- **1600 mm/s**

(2) C is:

- **850mm for multibeam protections**
- **1200mm for single optics systems**

With multibeam light curtains, beam height from the ground must comply with the following chart:

		4 beams	3 beams	2 beams	1 beam
Beams height (mm)	1st	300	300	400	750
	2nd	600	700	900	
	3rd	900	1100		
	4th	1200			

Tab. 4 Beams height for photocells protections

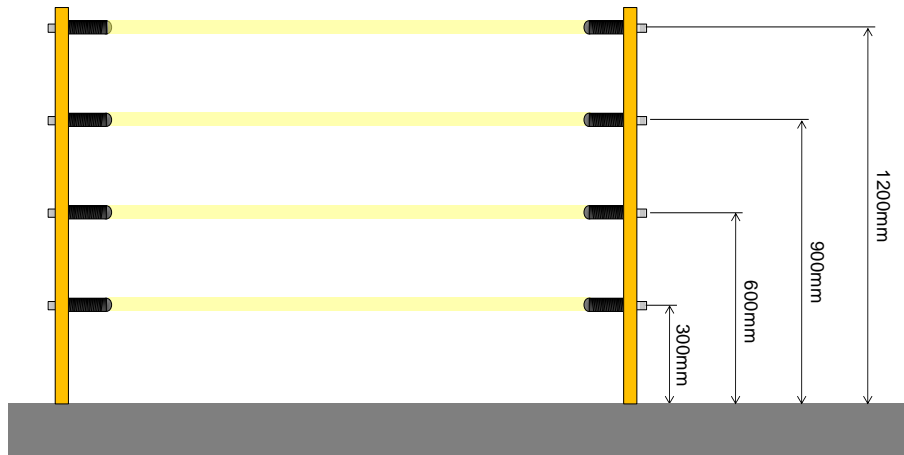

Fig. 6 Photocells installation heights for 4 beams protections



The reference safety norm is EN 13855 "Safety of machinery -- Positioning of safeguards with respect to the approach speeds of parts of the human body" The following information is to be considered as indicative and concise. For correct safety distance please refer to complete standard EN 13855.

- Example: light curtain with 4 S5 photocells

$$S = K (t_1 + t_2 + t_3) + C$$

where:

t_1	=	SG-BWS-T4 response time	29 ms
t_2	=	S5 response time	1.5 ms
t_3	=	machine total stopping time	290 ms
P	=	850 mm for devices with resolution \geq 40 mm.	850 mm

$$S = 1600 \cdot 0.321 + 850 = 1364 \text{ mm}$$

3.5. Minimum distance from reflecting surfaces

Reflecting surfaces placed near the light beams of the safety device (over, under or laterally) can cause passive reflections. These reflections can compromise the recognition of an object inside the controlled area.

However, if the RX receiver detects a secondary beam (emitted again by the side-reflecting surface) the object might not be detected, even if the object interrupts the main beam.

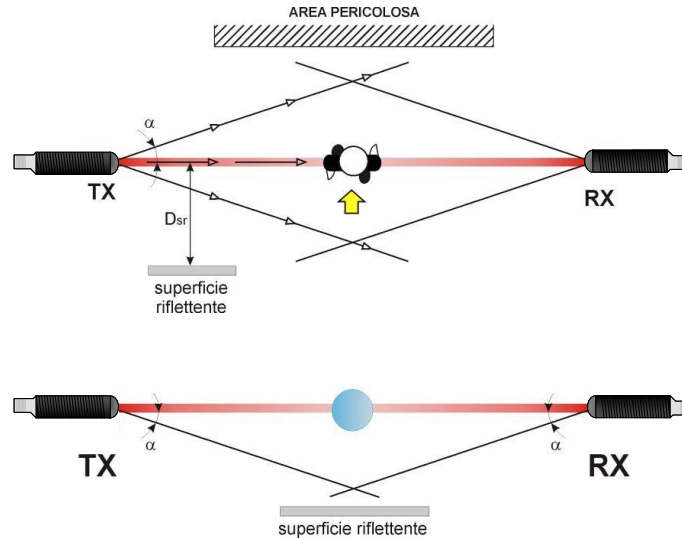

Fig. 7 Distance from reflecting surfaces

It is thus important to position the photocells according to the minimum distance D_{sr} from reflecting surfaces.

The minimum distance depends on:

- operating distance between emitter (TX) and receiver (RX);
- real opening angle of ESPE (EAA), especially:
- for ESPE type 4 (S5-ST4, SL5-ST4, S300): EAA = 5° ($\alpha = \pm 2.5^\circ$)
- for ESPE type 2 (S5-ST2): EAA = 10° ($\alpha = \pm 5^\circ$)

The formula to get D_{sr} is the following:

$$\left\{ \begin{array}{l} D_{sr} \text{ (m)} = 0.15 \\ D_{sr} \text{ (m)} = 0.5 \times \text{operating distance (m)} \times \text{tg (EAA)} \end{array} \right. \begin{array}{l} \text{for operat. dist. } < 3 \text{ m} \\ \text{for operat. dist. } \geq 3 \text{ m} \end{array}$$

3.6. Sensors Interference

When several safety devices must be installed in adjacent areas, interference between the emitter of one device and the receiver of the other must be avoided.

SG-BWS-T4 monitors possible interference between photocells and locks out if any interference is detected.

Suitable installation precautions could avoid any interference issue between similar devices. This typically applies to cases when many devices are installed side-by-side and in line, such as for systems featuring several goods loading/unloading areas, parallel one to the other and whose entrance is protected by safety light curtains.

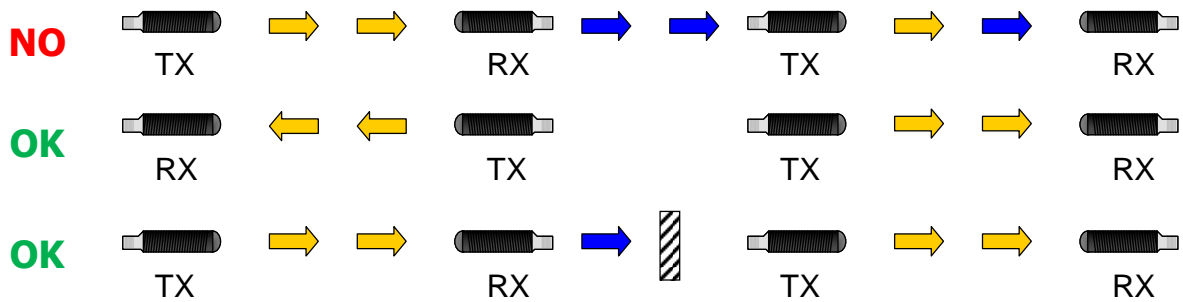

Fig. 8 Sensors disposal in order to avoid interferences

To make sure that photocell parallel beams do not create interference, it is necessary to install the photocells considering a minimum centre distance D_{do} that depends on operating distance D_{op} . To make this concept clearer, the chart below shows it for the S5-ST2, S5-ST4, SL5-ST4 series photocells.

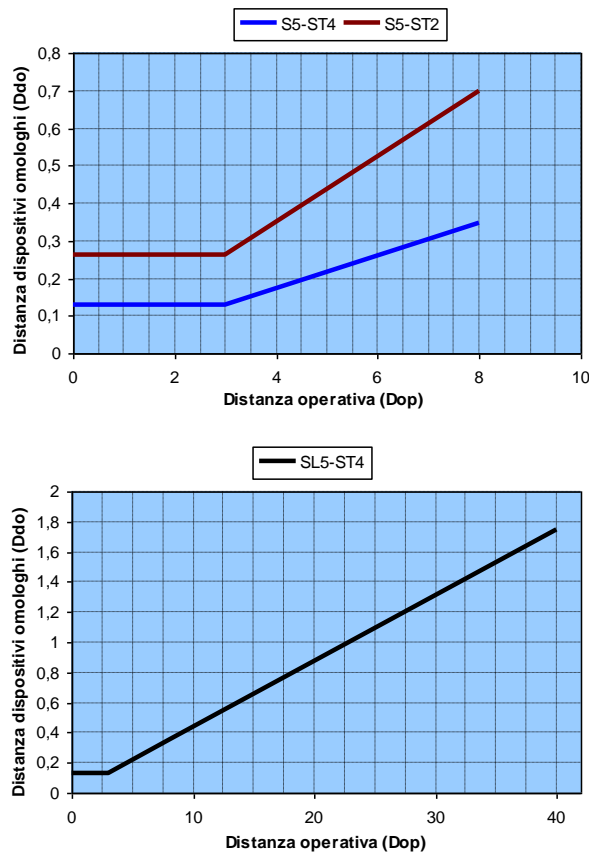

Fig. 9 Distance between equal sensors

3.7. Installing the safety control unit

The SG-BWS-T4 control unit is simply installed onto an OMEGA/DIN rail placed inside a control panel.

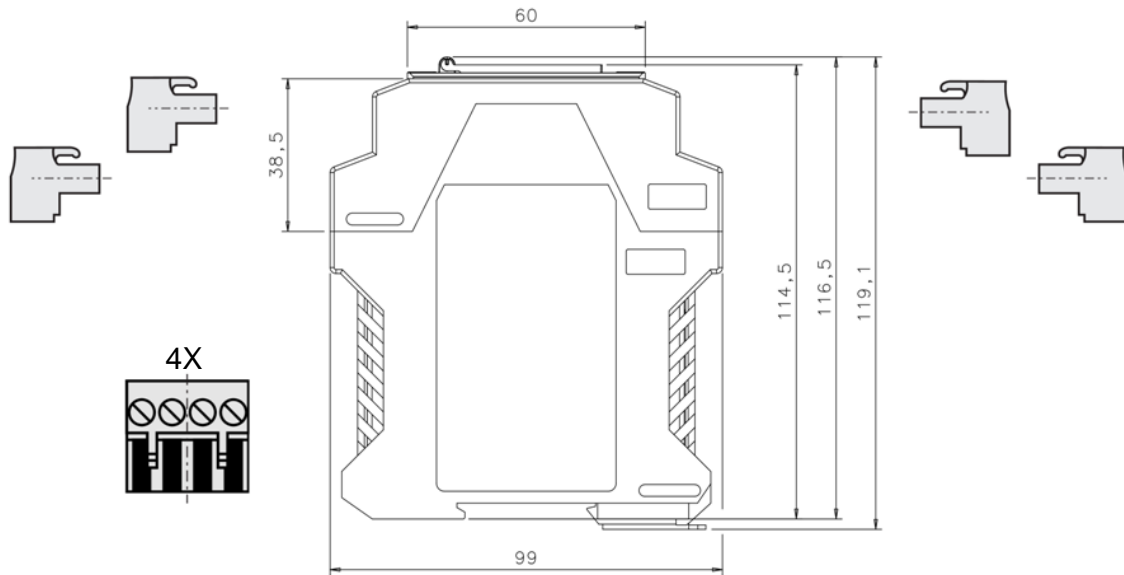

Fig. 10 Safety Control Unit mounting

The 4-pole connection terminals can be disconnected quite easily using a flat-blade screwdriver and can be connected by hand.

3.8. Installing the sensors

S5 and SL5 sensors can be installed exploiting the body M18x1 thread, on through hole (\varnothing 18 mm), using the two nuts supplied.

Various adjustable brackets are available to help sensor positioning (see 10.3 "Accessories"). Please refer to the photocell user manual for further details about installation.



Upon installation, make sure to correctly align the emitter and receiver. Emitter and receiver optics shall be on the same axis.

Take any due precaution to reduce vibrations when application requirements are stricter than specifications indicated under section 9 "Technical data"

During assembly, strictly comply with the instructions given under 3.4 "Minimum installation distance" and 3.5 "Minimum distance from reflecting surfaces"

- **Use of deviating mirrors**

The control of any dangerous area, with several but adjacent access sides, is possible using only one safety device and well-positioned deviating mirrors.

The figure shows a possible solution to control three different access sides, using two mirrors placed at 45° with respect to the beams.

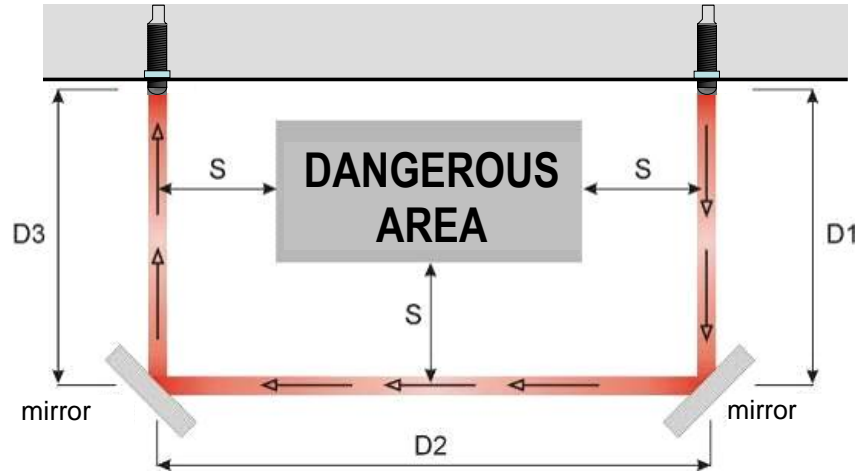

Fig. 11 Deviating Mirros

- The operator must respect the following precautions when using the deviating mirrors:
- **It is very hard to align the receiver and the transmitter when using deviating mirrors: a tiny angular shift of the mirror is enough to have a misalignment.**
- **The minimum safety distance (S) must be respected for each single section of the beams.**
- **The effective operating range decreases by about 15% by using only one deviating mirror, the percentage further decreases by using 2 or more mirrors (for more details refer to the technical specifications of the mirrors used).**
- **The presence of dust or dirt on the reflecting surface of the mirror causes a drastic reduction in the range.**

4. ELECTRICAL CONNECTION

4.1. Important installation tips



Do not place connection cables in contact with or near high-voltage cables and/or cable undergoing high current variations (e.g. motor power supplies, inverters, etc.);

Do not connect in the same multi-pole cable the wires for control unit safety outputs or the OSSD wires of different light curtains.

Do not connect in the same multi-pole cable both emitter and receiver of a set of photocells.

All devices are protected internally against overvoltage and overcurrent: the use of other outer parts is not recommended.

4.2. External relays connection for machine control

For SG-BWS-T4 to work as a safety device an external MPCE (Machine Primary Control Equipment) must be connected that controls main machine power supply.

Fig. 12 shows the connection to 2 external safety relays that can be monitored by SG-BWS-T4 by means of the EDM connection.

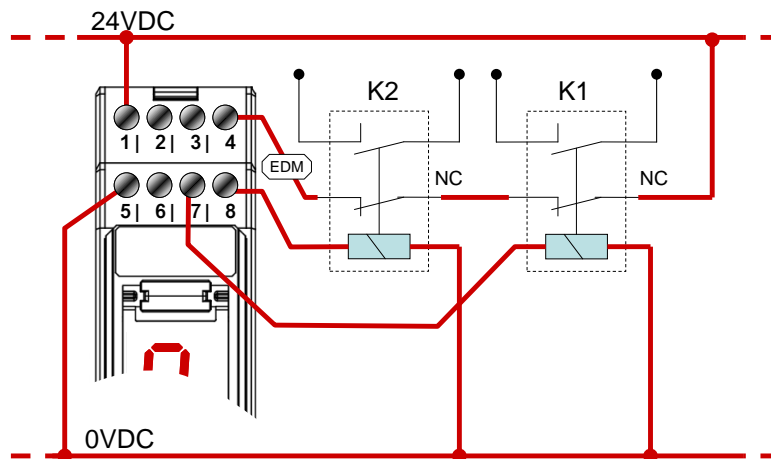

Fig. 12 External Relay Connection

4.3. Minimum connections (1 photocell, no EDM, automatic restart)

The control unit terminals layout and the minimum connection to check system operation are shown below. The photocells power (blue and brown wires) must be connected to the same power supply of SG-BWS-T4.

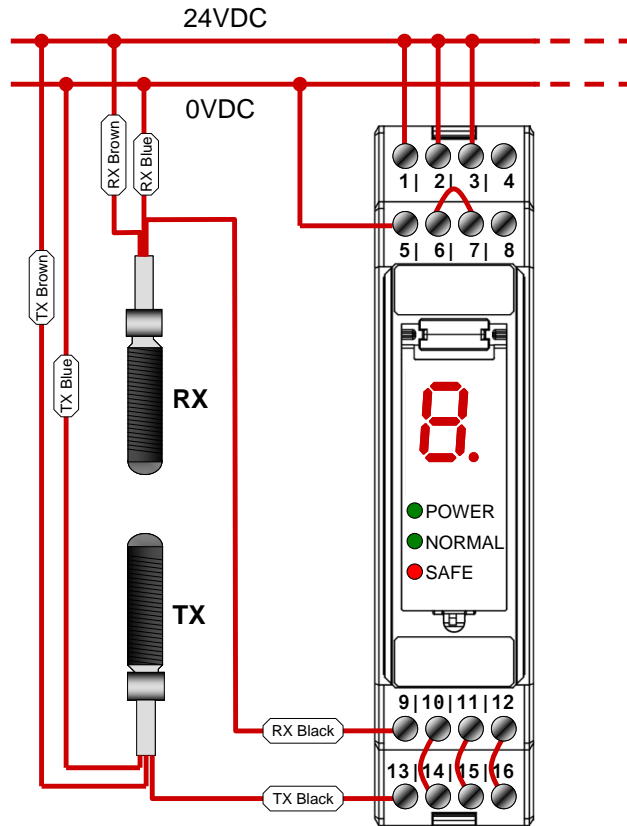

Fig. 13 Minimum connection for function test

SIGNAL	CONTACT	CONNECTION
VDC	1	24 Vdc ext.
START/TEST/RESET	2	24 Vdc ext.
EDM ENABLE	3	24 Vdc ext.
OV	5	0 Vdc ext.
MAN/AUTO	6	OSSD1 (7)
RX1	9	PNP output of receiver photocell 1 (black)
RX2	10	TX2 (14)
RX3	11	TX3 (15)
RX4	12	TX4 (16)
TX1	13	TEST of emitter photocell 1 (black)

Tab. 5 Minimum connection details for function test

4.4. Complete list of connections

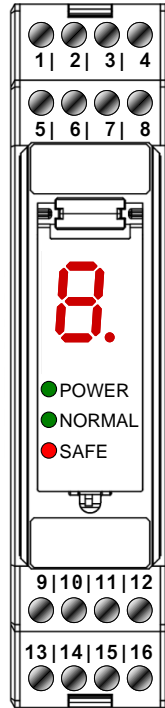

Fig. 14 Connection clamps disposal

SIGNAL	CONTACT	CONNECTION
VDC	1	24 Vdc ext.
START/TEST/RESET	2	- NC contact toward 24VDC
EDM ENABLE	3	- 24VDC → EDM DISABLED - NOT CONNECTED → EDM ENABLED
ENABLE	4	- NC contact of external relay toward 24VDC (with EDM enabled) - NOT CONNECTED (with EDM disabled)
0 V	5	0 Vdc ext.
MAN/AUTO	6	- OSSD1 (7) → AUTOMATIC RESET - OSSD2 (8) → MANUAL RESET
OSSD1	7	External relay coil 1 (positive)
OSSD2	8	External relay coil 2 (positive)
RX1	9	PNP output of receiver photocell 1 (black)
RX2	10	PNP output of receiver photocell 2 (black)
RX3	11	PNP output of receiver photocell 3 (black)
RX4	12	PNP output of receiver photocell 4 (black)
TX1	13	TEST of emitter photocell 1 (black)
TX2	14	TEST of emitter photocell 2 (black)
TX3	15	TEST of emitter photocell 3 (black)
TX4	16	TEST of emitter photocell 4 (black)

Tab. 6 Full connection list

The following paragraphs deal with the wiring of each single function (Edm, Start ...) in more detail.

4.5. Connecting the safety photocells:

0 to 4 safety photocells can be connected to the SG-BWST-4.
Connections required for installing 4 photocells:

SIGNAL	CONTACT	CONNECTION
RX1	9	PNP output of receiver photocell 1 (black)
RX2	10	PNP output of receiver photocell 2 (black)
RX3	11	PNP output of receiver photocell 3 (black)
RX4	12	PNP output of receiver photocell 4 (black)
TX1	13	TEST of emitter photocell 1 (black)
TX2	14	TEST of emitter photocell 2 (black)
TX3	15	TEST of emitter photocell 3 (black)
TX4	16	TEST of emitter photocell 4 (black)

Tab. 7 Safety photocells connections

If not all 4 photocells are installed, it is necessary to make a jumper to connect the set of TXn-RXn contacts not in use.

The diagram below shows an example where two sets of photocells are connected. **The control unit does not power** the photocells, it is hence necessary to **connect all power cables** (brown and blue cables) **to the same power supply as SG-BWS-T4.**

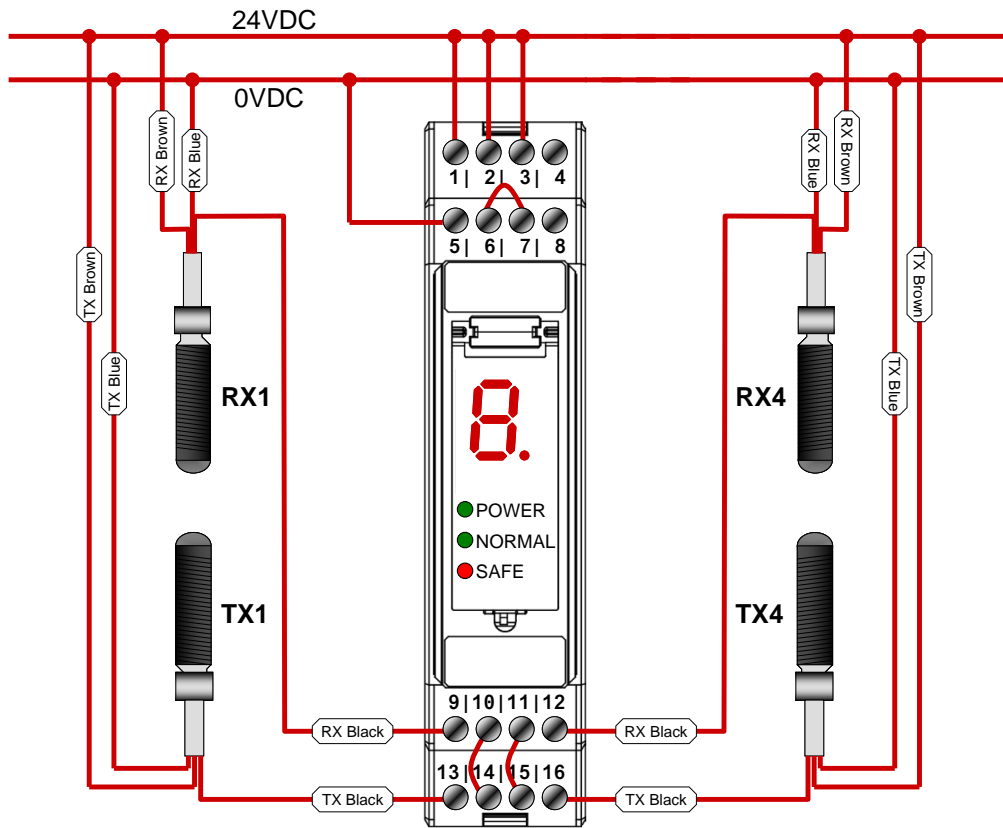

Fig. 15 Safety photocells connection

Photocell connectors are hard-wired as follows:



4.6. Connecting the safety photocells for SG-BWS-T4-2 model:

0 to 8 safety photocells can be connected to the SG-BWS-T4 in series of 2.
Connections required for installing 8 photocells:

SIGNAL	CONTACT	CONNECTION
RX2	9	PNP output of receiver photocell 2 (black)
RX4	10	PNP output of receiver photocell 4 (black)
RX6	11	PNP output of receiver photocell 6 (black)
RX8	12	PNP output of receiver photocell 8 (black)
TX1	13	TEST of emitter photocell 1 (black)
TX3	14	TEST of emitter photocell 3 (black)
TX5	15	TEST of emitter photocell 5 (black)
TX7	16	TEST of emitter photocell 7 (black)

Tab. 8 Safety photocells connections

If not all 8 photocells are installed, it is necessary to make a jumper to connect the set of TXn-RXn contacts not in use.

To each TXn-RXn can also be connected a single TX/RX couple as in SG-BWS-T4 model.

The diagram below shows an example where 4 sets of photocells are connected in series of 2.

The control unit does not power the photocells, it is hence necessary to connect all power cables (brown and blue cables) to the same power supply as SG-BWS-T4.

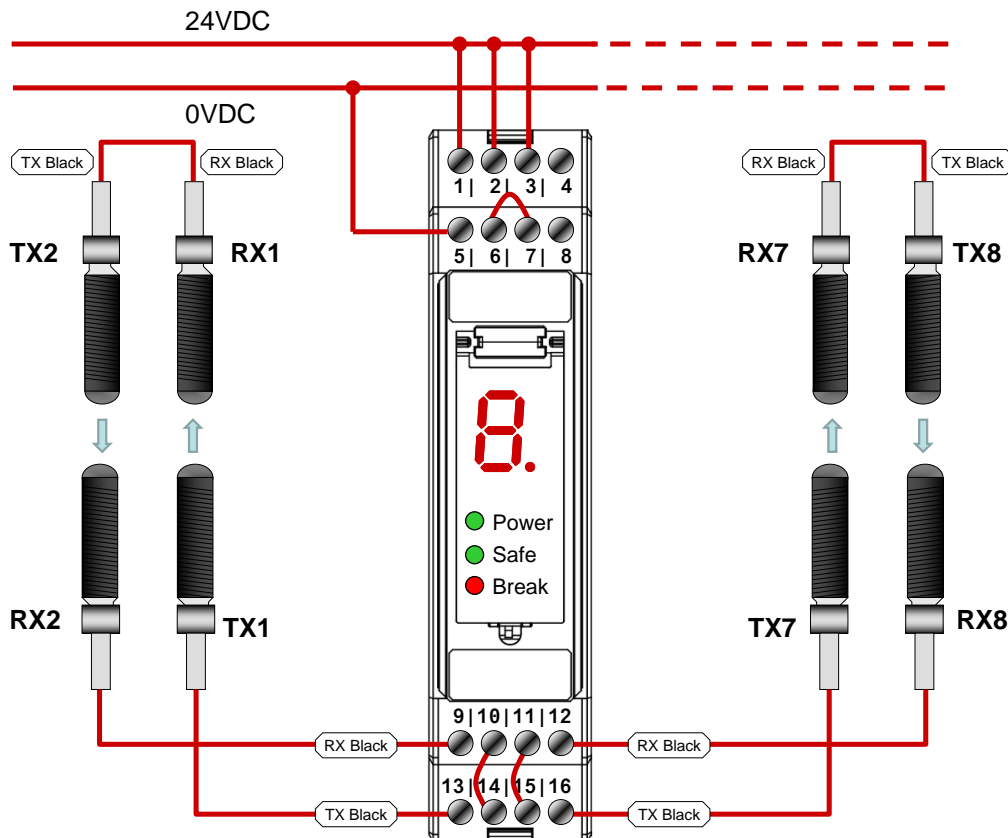

Fig. 16 Safety photocells series connection for SG-BWS-T4-2 model only



Carefully check there is no mutual interference between photocells connected in series on the same channel. This can be achieved mounting Transmitters and Receivers on opposite side as in Fig. 16

4.7. Connecting the external relays and EDM

To use the EDM function available in the BW-ST4, simply connect devices as shown below.

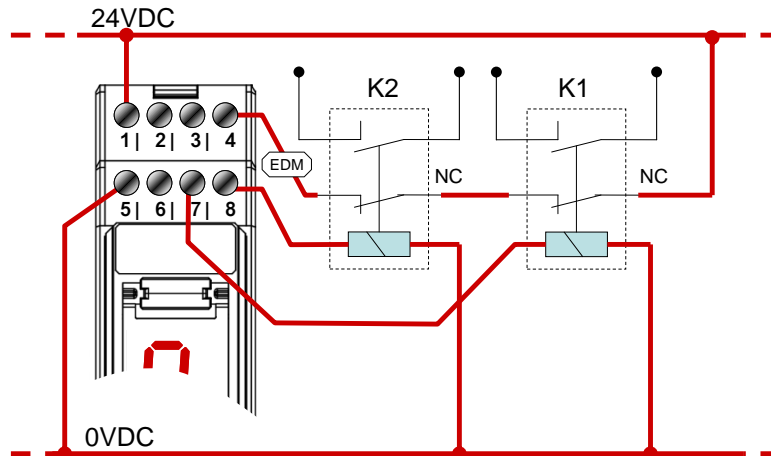

Fig. 17 EDM connections

External devices monitoring (EDM) checks whether the relays (or other control devices) have really opened the power circuit due to a dangerous condition detected by the safety sensors. This function monitors normally closed contacts upon OSSD status change.

EDM function is enabled, terminal 3 is left disconnected (see 4.3 “Complete list of connections”). Activation is confirmed by the decimal point (dot) being displayed on control unit screen.

If EDM is not used, it will be necessary to leave terminal 4 disconnected or consider 0VDC (see 4.3).

OSSDs STATE

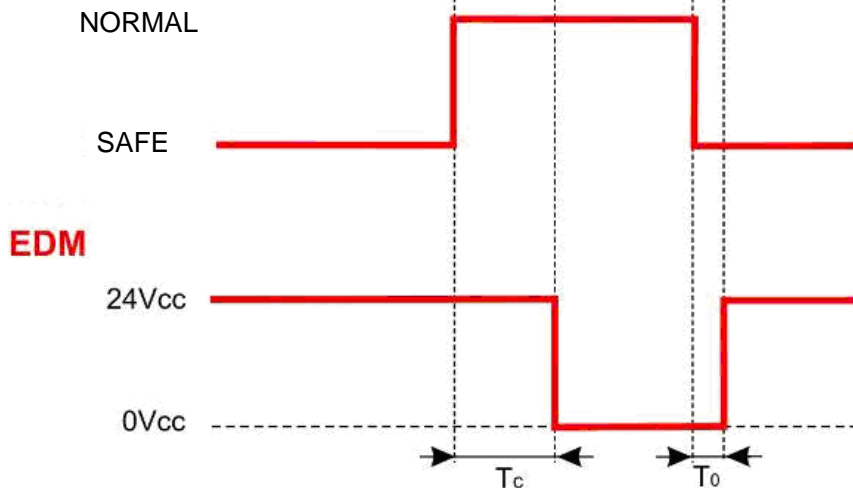

- $T_c \geq$ 350 msec: time after SAFCN OFF-ON switch when EDM test is performed.
- $T_0 \geq$ 100 msec: time after SAFCN ON-OFF switch when EDM test is performed.

Fig. 18 EDM Timings

To exploit the EDM function available in the SG-BWS-T4 system, you simply have to connect in series the two NC contacts of the external relays, then connect the free ends respectively to 24V and contact 4 of control unit, as shown in the above diagram.

4.8. Reset mode and connection of the Start/Test/Reset push-button

The interruption of a beam due to an opaque object causes the opening of OSSD outputs and the stop of the safety control unit (SAFE condition, ●SAFE).

ESPE standard operation can be reset (OSSD safety outputs closing, NORMAL OPERATION condition, ●NORMAL) in two different ways:

- **Automatic reset:** After its activation ESPE resets to standard operating condition once the object has been removed from the controlled area.
- **Manual reset:** After its activation, ESPE resets to standard operating condition only once the reset function has been enabled and provided that the object has been removed from the controlled area. This condition determines interlock status, pointed out on the display by the relevant warning (see section 6 “Diagnostics and warnings”). The reset command will only be effective if button is held for over 0.5s but less than 5s.

Automatic or manual reset mode is selected by duly connecting terminal 6 (see 4.3 “Complete list of connections”).



Carefully assess risk conditions and reset modes. In applications protecting access to dangerous areas, the automatic reset mode is potentially unsafe if it allows the operator to pass completely beyond the sensitive area. In this case, manual resetting is required.

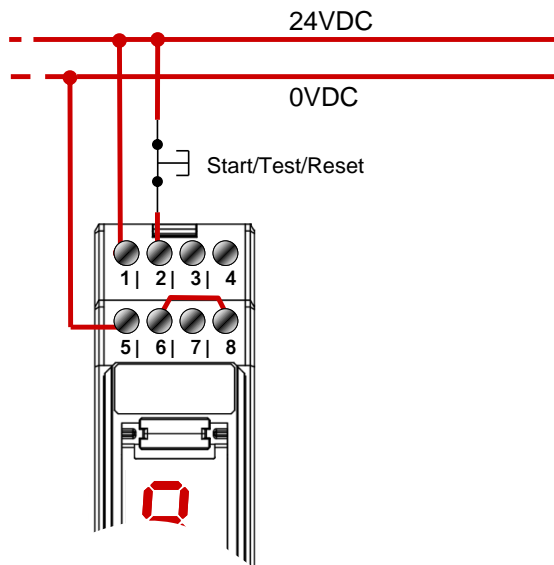

Fig. 19 Start/Test/Reset button connection

Reset control shall be output by a suitable push-button with NC contact towards 24VDC, as shown in the above diagram.

The START signal is active low.



Carefully spot the most suitable position for the reset push-button! Install the reset push-button outside the dangerous area so as it is not possible to activate it from inside the area. The operator shall always be able to see the whole dangerous area whenever activating the reset push-button.

- **Test function**

The Test command temporarily disables beam emission in order to check switching to SAFE status. This function can be activated by opening (for at least 0.5 seconds) an NC outer contact (START/TEST/RESET push-button).

The TEST signal is active low.

When this function is activated, ESPE switches to SAFE status and displays the relevant warning (see section 6 “Diagnostics and warnings”).

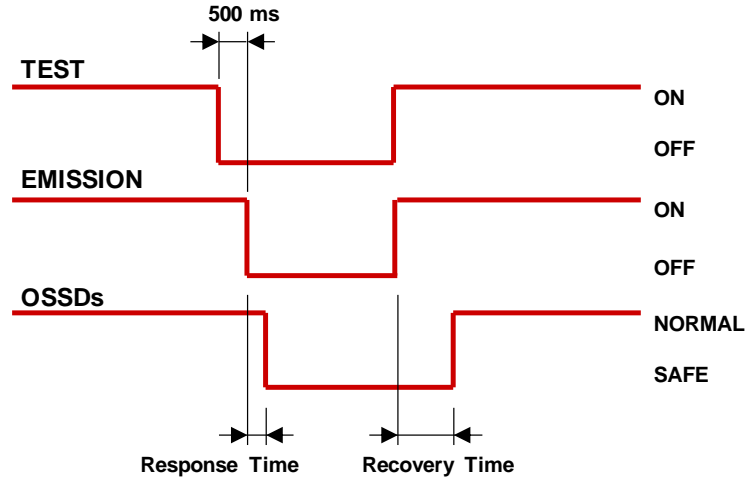

Fig. 20 Test function timings

- **Reset function**

The same push-button can be used to reset the system after a lockout and the relevant error warning.

Hold the push-button for **at least 5s** to activate the **reset function**.

If the push-button is held depressed when device is being turned on, the control unit switches to “alignment” mode: please refer to paragraph 5.2 “Safety devices alignment”.

The RESET signal is active low.

5. COMMISSIONING



Before commissioning a system protected by SG-BWS-T4 it shall be inspected and checked by a qualified technician who shall state its suitability. Please refer, for further details on this subject, the instructions given under paragraph 3.1 “Safety information”.

5.1. Screen indications upon switch-on

As soon as control unit is powered, all 7 display segments will turn on. The display will then switch off and all segments are quickly activated one after the other. The display will then switch off again meaning that the device is ready for use. When the display does not switch off, there is an error in the device (see section 6 “Diagnostics and warnings”).

The meaning of displayed values is as follows:

Display	Meaning
	7-segment display test routine. All segments are activated one after the other.
Nothing on screen (only decimal point if EDM on)	The device is ready for use
Any other view	System failure. Refer to section 6 “Diagnostics and warnings”

Tab. 9 Startup visualization sequence

5.2. Safety devices alignment

Once all components are in place and connected, emitters and receivers shall be mutually aligned.

In alignment mode, the SAFCN safety outputs are open. The alignment mode and relevant procedure are described here below:

- **Cut off control unit power supply.**
- **Hold the Test push-button depressed (open Test contact).**
- **Power on the control unit.**
- **The 7-segment display shows the first device to be aligned (Photocells 1-4, light curtains 5-6)**
- **Align the indicated device until display will indicate the following device to be aligned or alignment completed warning (H flashing).**

When alignment is completed, cut off control unit power, release Test push-button (close the contact) and restore control unit power.

The control unit will run the initial test routines and display a countdown, the display will then turn off and the control unit will switch to NORMAL OPERATION status (● NORMAL).

Now carry out the following inspections:

- **The ESPE stays in ●SAFE mode during photocells and light curtains beam interruption using the suitable “Test Piece”, along the entire protected area.**
- **Enabling the TEST function, the SAFCN outputs should open (●SAFE and the controlled machine stops).**
- **The response time upon machine STOP (including response time of the ESPE and of the machine) is within the limits defined for the calculation of the safety distance (see section 3 “Installation”).**
- **The safety distance between the dangerous areas and the safety sensors is in accordance with the instructions included in section 3 “Installation”.**
- **Access of a person between sensors and machine dangerous parts is not possible nor is it possible for him/her to stay there.**
- **Access to the dangerous area of the machine from any unprotected area is not possible.**

During alignment or normal operation, make sure that the photocells connected to the same or other units do not interfere with each other. Should you find interference, change their position, for instance you could set some emitter sets on the side of the other receivers. In case of interference, the control unit will lock out and display the relevant error code.

6. DIAGNOSTICS AND WARNINGS

SG-BWS-T4 is equipped with a user interface featuring 3 LEDs and a 7-segment display.

LED	Indication
● Power	Device is powered correctly
● NORMAL	No danger: safety outputs closed
● SAFE	Danger or fault: safety outputs open
	The 7-segment display shows detailed information on control unit current status

Tab. 10 Signalling interface

6.1. Normal operation signalling

The table below specifies all possible screen indications and the system status or failure associated to each of them.

INDICATION	STATUS	DESCRIPTION	TO DO
<ul style="list-style-type: none"> ● POWER ○ NORMAL ○ SAFE 	Alignment	The display shows the first device to be aligned and then the others in a sequence (1 to 4).	Align the safety devices (see 5.2)
<ul style="list-style-type: none"> ● POWER ○ NORMAL ○ SAFE 	Alignment	All connected devices are aligned	Close the Test contact (Pin 2) and restart the control unit to switch to normal operation (see 5.2)
<ul style="list-style-type: none"> ● POWER ○ NORMAL ● SAFE 	SAFE	The indicated safety device beam is interrupted. If many devices are in this status, the first one is indicated, then the others in a sequence (1 to 4).	Clear the area or check device connections
<ul style="list-style-type: none"> ● POWER ● NORMAL ○ SAFE 	NORMAL OPERATION	The device is in normal operating conditions and monitored area is safe.	
<ul style="list-style-type: none"> ● POWER ●* NORMAL ● SAFE 	Interlock	Waiting for the START command in manual reset mode	Push reset control
<ul style="list-style-type: none"> ● POWER ●/○ NORMAL ○/● SAFE 	NORMAL OPERATION/ SAFE	The decimal point indicates that the EDM function is active (see 4.7)	
<ul style="list-style-type: none"> ● POWER ○ NORMAL ● SAFE 	SAFE	TEST push-button pressed (contact 2 open)	Check TEST push-button connections (see 4.6)

Tab. 11 Normal operation signalling

6.2. Failure state signalling

INDICATION	STATUS	DESCRIPTION	TO DO
<ul style="list-style-type: none"> ○ POWER ○ NORMAL ○ SAFE 	Off	Power disconnected or inner fuse blown due to overload.	Check power supply
<ul style="list-style-type: none"> ● POWER ○ NORMAL ● SAFE 	FAILURE LOCKOUT	It is impossible to determine selected reset mode	Check MAN/AUTO switch connection (terminal 6, see 4.3)
<ul style="list-style-type: none"> ● POWER ○ NORMAL ● SAFE 	FAILURE LOCKOUT	OSSD test routine has failed.	Check OSSD outputs connections (see 4.3). Make sure there is no short-circuit and check the features of the load downstream of the OSSD (see section 9)
<ul style="list-style-type: none"> ● POWER ○ NORMAL ● SAFE 	FAILURE LOCKOUT	EDM test has failed	Check EDM connections (see 4.5) or disable EDM function (see 4.3) if you do not wish to use it.
<ul style="list-style-type: none"> ● POWER ○ NORMAL ● SAFE 	FAILURE LOCKOUT	Start signal time-out tripped.	Make sure you hold the Start button depressed for less than 5s.
<ul style="list-style-type: none"> ● POWER ○ NORMAL ● SAFE 	FAILURE LOCKOUT	One of microprocessor tests has failed	Disconnect power supply and reconnect it. If error persists, please contact the Technical Service.
<ul style="list-style-type: none"> ● POWER ○ NORMAL ● SAFE 	FAILURE LOCKOUT	Test of indicated safety sensor has failed.	Make sure there is no interference across different photocell sets.

Tab. 12 Failure state signalling

7. PERIODICAL CHECKS AND WARRANTY

7.1. Periodical checks

The following is a list of recommended check and maintenance operations that should be periodically carried out by qualified personnel.

Check that:

The ESPE stays in OSSD disabled state (● **SAFE**) mode during photocells beam interruption using the suitable "Test Piece", along the entire protected area.

- Sensors are correctly aligned: by slightly pressing each sensor side, in both directions, the system shall stay in ● NORMAL mode
- Enabling the TEST function, the SAFCN outputs should open (● SAFE and the controlled machine stops).
- The response time upon machine STOP (including response time of the ESPE and of the machine) is within the limits defined for the calculation of the safety distance (see section 3 "Installation").
- The safety distance between the dangerous areas and the safety sensors is in accordance with the instructions included in section 3 "Installation".
- Access of a person between sensors and machine dangerous parts is not possible nor is it possible for him/her to stay there.
- Access to the dangerous area of the machine from any unprotected area is not possible.
- The ESPE, the sensors and the external electrical connections are not damaged.
- The frequency of checks depends on the particular application and on the operating conditions of the safety light curtain.

7.2. Warranty

Datalogic guarantees each brand new SG-BWS-T4 system, under standard use conditions, against manufacturing defects in material and workmanship for a period of 36 (thirty-six) months from the date of manufacturing.

Datalogic will not be liable for any damages to persons and things caused by failure to stick to the correct installation modes and device use.

Warranty validity is subjected to the following conditions:

- User shall notify Datalogic the failure within thirty-six months from product manufacturing date.
- Failure or malfunction shall not have been originated directly or indirectly by:
- Use for unsuitable purposes;
- Failure to comply with the intended use prescriptions;
- Negligence, unskillfulness, wrong maintenance;
- Repairing, changes, adaptations not made by Datalogic personnel, tampering with the device, etc.;
- Accidents or crashes (even due to transportation or by force majeure causes);
- Other causes not depending from Datalogic.

If the device does not work, send the unit to Datalogic. The Customer is responsible for all transport charges and damage risks or material loss during transport, unless otherwise agreed.

All replaced products and parts become a property of Datalogic.

Datalogic acknowledges no other guarantees or rights apart from the ones expressly specified above.

Therefore no claims for damages due to afforded costs, suspension of working activities or other factors somehow linked with product or product parts failure will be accepted.

In case of problems, please contact Datalogic Service Department.

Service Department

Tel.: +39 051 6765611

Fax.: +39 051 6759324

www.datalogic.com

8. DEVICE MAINTENANCE

SG-BWS-T4 and photocells of the S5, SL5, S300 series do not require any special servicing.

To avoid the reduction of the operative distance, optics protective front surfaces shall be cleaned at regular intervals.

To this end, use soft cotton cloths dampened in water; do not apply too much pressure onto the surface so as not to make it dull.

Please do not use on plastic surfaces or optics:

- alcohol or solvents
- wool or synthetic cloths
- paper or other abrasive materials

8.1. Product disposal

Under current Italian and European laws, Datalogic is not obliged to take care of product disposal at the end of its useful life.

Datalogic recommends to dispose of the product in compliance with local laws or contact authorised waste collection centres.

9. TECHNICAL DATA

- **SG-BWS-T4**

Electrical data	
Supply voltage:	24 Vdc \pm 15%
Power Consumption:	2.1 W max
Response Time:	SG-BWS-T4: 29 ms SG-BWS-T4-2: 33 ms
Safety category:	Type 4 (ref. EN 61496-1) SIL3 (ref. EN 62061) PL e – Cat. 4 (ref EN ISO 13849-1 2008)
Outputs:	2 PNP
Short-circuit protection:	1.4 A max
Output current:	0.5 A max / each output
Output voltage – status ON:	Vdd –1 V min
Output voltage – status OFF:	0.2 V max
Capacitive load:	2.2 μ F @ 24Vdc max
Cables length (for power supply):	50 m. max
Pollution rating:	2
Mechanical and environmental data	
Operating temperature:	0...55°C
Storage temperature:	-25...+ 70 °C
Temperature rating:	T6
Humidity:	15...95 % (no condensation)
Mechanical protection:	IP 20 (EN 60529)
Vibrations:	Width 0.35 mm, frequency 10 ... 55Hz; 20 sweep per axis, 1octave/min (EN 60068-2-6)
Shock resistance:	16 ms (10 G) 1,000 shocks per axis (EN 60068-2-29)
Housing material:	Nylon PA66
Weight:	125 g

Tab. 13 SG-BWS-T4 technical data

- Safety Parameters of Stand Alone SG-BWS Series Control Unit**

Product	EN ISO 13849-1	EN 954-1	EN IEC 61508	EN IEC 62061	Prob. of danger failure/hour	Life span	Mean Time to Dangerous Failure	Average Diagnostic Coverage	Safe Failure Fraction	Hardware Fault Tolerance
	PL	CAT	SIL	SIL CL	PFHd (1/h)	T1 (years)	MTTFd (years)	DC	SFF	HFT
SG-BWS-T4	e	4	3	3	5.69E-09	20	201	99.00%	99.74%	1
SG-BWS-T4-2	e	4	3	3	5.69E-09	20	201	99.00%	99.74%	1

- Safety Parameters of S5/SL5/S300 in combination Sensors**

SINGLE BEAM SAFETY SENSORS ¹					Safety Parameters in combination with SG-BWS-T4 series Safety Control Units				
	TYPE	MODEL	EMITTER / RECEIVER	ORDER NUMBER	PL/SIL in combination with SG-BWS-T4 Series	PFHd in combination with SG-BWS-T4 ²	PFHd in combination with SG-BWS-T4-MT ²	PFHd in combination with SG-BWS-T4-2 ³	PFHd in combination with SG-BWS-T4-2-MT ³
S5	2	S5-5-G8-62-SG-ST2	Emitter	952051870	SIL 1 / Pl c	3.90E-09	3.64E-09	5.69E-09	5.43E-09
		S5-5-F8-92-SG-ST2	Receiver	952051890					
	4	S5-5-G8-62-SG-ST4	Emitter	952051910	SIL 3 / Pl e	3.90E-09	3.64E-09	5.69E-09	5.43E-09
		S5-5-F8-92-SG-ST4	Receiver	952051930					
SL5	4	SL5-5-G-82-SG-ST4	Emitter	952501160	SIL 3 / Pl e	3.90E-09	3.64E-09	5.69E-09	5.43E-09
		SL5-5-F-92-SG-ST4	Receiver	952501170					
S300	2	S300-PR-5-G00-EX-SG-ST2	Emitter	951451320	SIL 1 / Pl c	3.62E-09	3.36E-09	5.13E-09	4.87E-09
		S300-PR-5-F00-OC-SG-ST2	Receiver	951451340					
	4	S300-PR-5-G00-EX-SG-ST4	Emitter	951451360	SIL 3 / Pl e	3.62E-09	3.36E-09	5.13E-09	4.87E-09
		S300-PR-5-F00-OC-SG-ST4	Receiver	951451380					
S300 DEFOGGING	2	S300-PR-5-G00-EX-M-SG-ST2	Emitter	951451330	SIL 1 / Pl c	3.62E-09	3.36E-09	5.13E-09	4.87E-09
		S300-PR-5-F00-OC-M-SG-ST2	Receiver	951451350					
	4	S300-PR-5-G00-EX-M-SG-ST4	Emitter	951451370	SIL 3 / Pl e	3.62E-09	3.36E-09	5.13E-09	4.87E-09
		S300-PR-5-F00-OC-M-SG-ST4	Receiver	951451390					

- S5-ST2/ST4, SL5-ST4**

For technical details about S5, SL5 series see the relative user manual.

- S300**

For technical details about S300 series see the relative user manual.

¹ The photocells listed above are certified and must be used only with safety control units from SG-BWS Series. Neither technical and operational compatibility nor certifications are guaranteed if they are used with other brand control units or old/obsolete Datalogic control units.

² Worst case calculation with 4 photocells installed.

³ Worst case calculation with 8 photocells installed.

10. ORDER DATA

- **Control Unit**

Component	Description	Code
SG-BWS-T4	TYPE 4 SAFETY CONTROL UNIT	957051000
SG-BWS-T4-2	TYPE 4 SAFETY CONTROL UNIT - 8 Single Beam Devices	957051030

- **Photocells**

S5 – M18 Tubular

Component	Description	Code
S5-5-G8-62-SG-ST2	S5-5-G8-62-SG-ST2 EMITTER 10/30VDC	952051870
S5-5-F8-92-SG-ST2	S5-5-F8-92-SG-ST2 RECEIVER 10/30VDC	952051890
S5-5-G8-62-SG-ST4	S5-5-G8-62-SG-ST4 EMITTER 10/30VDC	952051910
S5-5-F8-92-SG-ST4	S5-5-F8-92-SG-ST4 RECEIVER 10/30VDC	952051930
SL5-5-G-82-SG-ST4	SL5-5-G-82-SG-ST4 LASER EMITT. 40m M12	952501160
SL5-5-F-92-SG-ST4	SL5-5-F-92-SG-ST4 RIC 40m PNP LIGHT M12	952501170

S300 maxi

Component	Description	Code
S300-PR-5-G00-EX-SG-ST2	TYPE 2 EMITTER M12 CONNECTOR DC	951451320
S300-PR-5-G00-EX-M-SG-ST2	TYPE 2 EMITTER M12 CONN. DC DEFOGGING	951451330
S300-PR-5-F01-OC-SG-ST2	TYPE 2 RECEIVER M12 CONNECTOR DC	951451340
S300-PR-5-F01-OC-M-SG-ST2	TYPE 2 RECEIVER M12 CONN. DC DEFOGGING	951451350
S300-PR-5-G00-EX-SG-ST4	TYPE 4 EMITTER CONNETTORE M12 DC	951451360
S300-PR-5-G00-EX-M-SG-ST4	TYPE 4 EMITTER M12 CONN. DC DEFOGGING	951451370
S300-PR-5-F01-OC-SG-ST4	TYPE 4 RECEIVER M12 CONNECTOR DC	951451380
S300-PR-5-F01-OC-M-SG-ST4	TYPE 4 RECEIVER M12 CONN. DC DEFOGGING	951451390

- **Accessories**

Componente	Descrizione	Codice
SG-DM 150	DEVIATING MIRRORS H=150MM	95ASE1670

11. OVERALL DIMENSIONS

11.1. SG-BWS-T4

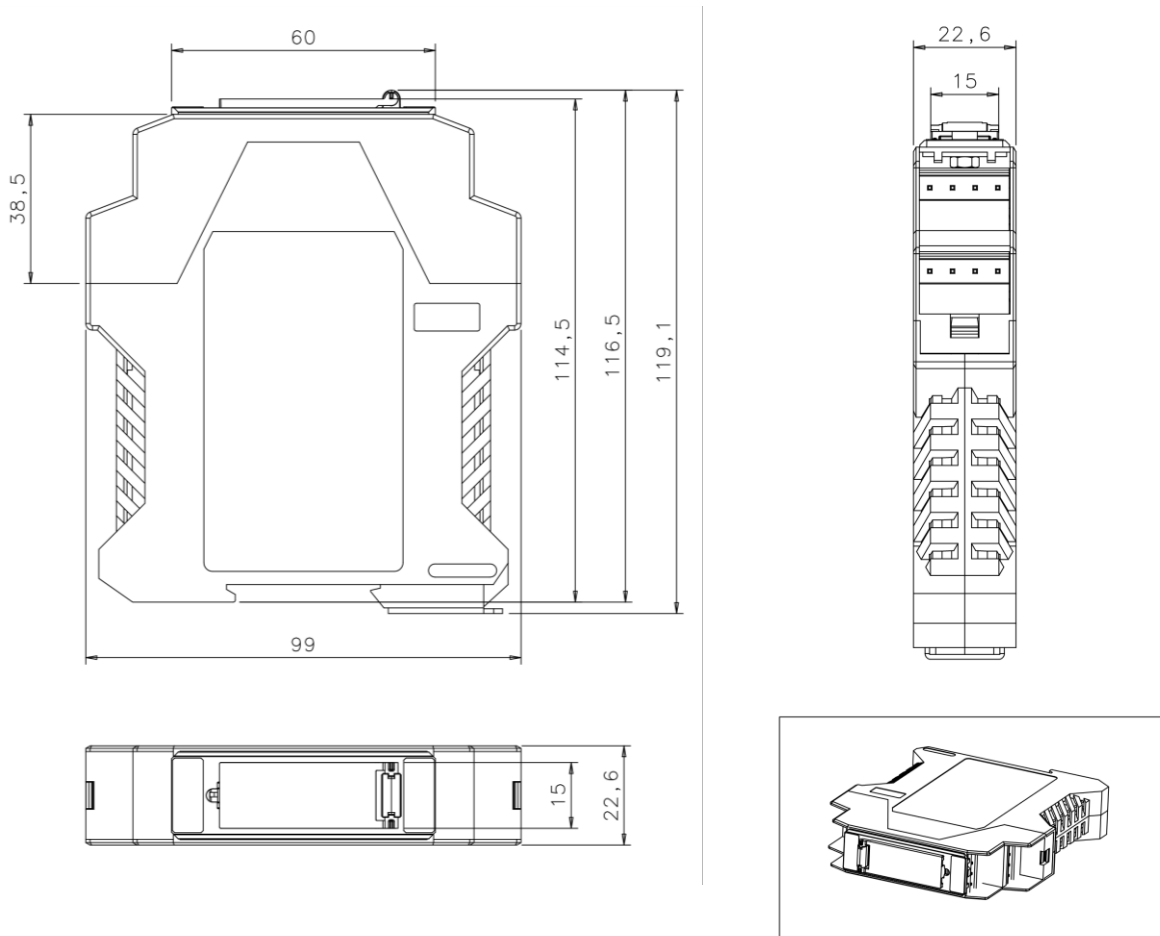

Fig. 21 SG-BWS-T4 Overall dimensions

11.2. S5-ST2,S5-ST4, SL5-ST4, S300

For overall dimensions of single beam photocells see the relative user manuals.

12. APPENDIX

12.1. FIGURE INDEX:

Fig. 1 SG-BWS-T4-MT Appearance and user interface 3

Fig. 2 Safety single beam photocells S5,SL5 series (appearance) 4

Fig. 3 Automatic warehouses protection with photocells 5

Fig. 4 Doors control by means of safety photocells 6

Fig. 5 Safety Distance 8

Fig. 6 Photocells installation heights for 4 beams protections 9

Fig. 7 Distance from reflecting surfaces 10

Fig. 8 Sensors disposal in order to avoid interferences 11

Fig. 9 Distance between equal sensors 11

Fig. 10 Safety Control Unit mounting 12

Fig. 11 Deviating Mirros 13

Fig. 12 External Relay Connection 14

Fig. 13 Minimum connection for function test 15

Fig. 14 Connection clamps disposal 16

Fig. 15 Safety photocells connection 17

Fig. 16 Safety photocells series connection for SG-BWS-T4-2 model only 18

Fig. 17 EDM connections 19

Fig. 18 EDM Timings 19

Fig. 19 Start/Test/Reset button connection 20

Fig. 20 Test function timings 21

Fig. 21 SG-BWS-T4 Overall dimensions 30

12.2. TABLES INDEX:

Tab. 1 User manual main contents 2

Tab. 2 Signalling LEDs 4

Tab. 3 Photocells signalling 4

Tab. 4 Beams height for photocells protections 8

Tab. 5 Minimum connection details for function test 15

Tab. 6 Full connection list 16

Tab. 7 Safety photocells connections 17

Tab. 8 Safety photocells connections 18

Tab. 9 Startup visualization sequence 22

Tab. 10 Signalling interface 23

Tab. 11 Normal operation signalling 23

Tab. 12 Failure state signalling 24

Tab. 13 SG-BWS-T4 technical data 27



 **DATALOGIC**

www.datalogic.com